

TAKSTAR® 得胜

MX1 Pro

调音台式直播声卡 Mixer Webcast Sound Card



使用手册 User Manual

中文目录.....	1-20
Content.....	21-41
前言.....	2
产品特性.....	2
包装清单.....	3
适用范围.....	3
系统要求.....	3
技术参数.....	4
主机参数.....	4
电池参数.....	4
接口详情.....	4
功能示意.....	5
使用说明.....	9
一、软件下载.....	9
二、手机直播/K歌.....	9
三、连接伴奏手机.....	11
四、电脑手机同步直播.....	12
五、音响K歌.....	13
六、自定义主播特效.....	13
七、蓝牙配对.....	15
八、OTG兼容模式.....	15
九、充电说明.....	16
故障处理.....	17
安全警示.....	18
关于图标含义解释.....	19
关于本说明书.....	19
环保说明.....	20

■ 前言

感谢您选购得胜MX1 Pro调音台式直播声卡,为了您能够更好的了解及使用本产品,建议您在使用前仔细阅读本说明书。

若存在有疑问或者您有宝贵的建议,可通过拨打得胜官方服务热线400 6828 333或微信扫描二维码关注得胜官方公众号与我们联系。



■ 产品特性

- 专为娱乐直播、带货直播、K歌、录音而设计,适用于智能手机、平板及电脑;
- 内置DSP数字芯片,麦克风混响量、变声量、电音速度等独立调节,可操作性强;
- 具有蓝牙播放功能,简化繁琐的线材连接,无线播放音乐更自由;
- 麦克风高、低音调节旋钮,满足不同人群的声音特点需求;
- 具备OTG功能,可通过USB与手机连接实现高清无损的录音、直播;
- 多彩炫酷的灯光控制,可通过灯控按键切换灯光变化效果;
- 具有8种主播特效,其中2种特效还可以自由更换,直播更具趣味性;
- 智能降噪,可屏蔽麦克风对环境噪音的拾取,唱歌更安静;
- 一键闪避功能,说话时背景音乐自动压低,适合直播时使用;
- 支持双手机、电脑三设备同步直播,多平台直播,助力直播吸粉;
- 内置大容量锂电池,超长续航,方便携带户外使用。

■ 包装清单

声卡.....	1台
音频线(规格:Φ3mm*1.2m).....	2条
Type-C数据线(规格:Φ4mm*1.2m).....	1条
6.3mm转3.5mm插头.....	2个
说明书.....	1份

■ 适用范围

手机/平板/电脑:K歌、直播、录音

适用APP:适用于各种娱乐直播APP及带货直播平台

■ 系统要求

兼容iOS、Android、windows

■ 技术参数

主机参数

数据传输:USB2.0

采样率:48KHz/16bit

频率响应:20Hz-20KHz(± 3 dB)

总谐波失真:THD $< 0.5\%$ 1KHz

耳机输出功率:167.7mW/32 Ω

耳机信噪比:90dB (A-Weighted)

主芯片:DSP

混响模式:Reverb

电音基调:12种基调Autotune

均衡处理:EQ

净重:约490g

电池参数

电池类型:锂电子电池

充电方式:DC 5V \rightleftharpoons 1.5A

电池容量:4400mAh

充电时间:约5小时

使用时间:约8小时(48V关闭时)

约6小时(48V开启时)

接口详情

音频接口:手机接口*2($\Phi 3.5$ mm)

伴奏接口($\Phi 3.5$ mm)

话筒接口1(XLR+ $\Phi 6.35$ mm)

话筒接口2($\Phi 3.5$ mm)

耳机接口*2($\Phi 6.35$ mm)

数据接口:Type-C接口

注:以上数据由得胜实验室测试得到,并拥有最终解释权!

功能示意

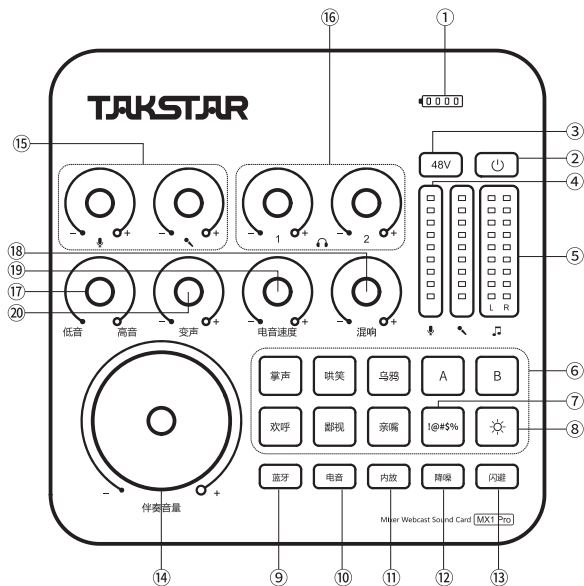

- ① 电量指示灯: 电池符号有四格, 一格为25%电量。剩下一格时, 红灯亮起, 表示电量不足, 需要及时充电。充电时, 逐格流水点亮指示灯, 充满电时, 指示灯满格显示;
- ② 电源按键: 循环长按电源按键2秒, 开启或关闭声卡。开机时, 电源指示灯长亮蓝光, 关机时, 电源指示灯熄灭;
- ③ 48V开关: 循环点按开启或关闭48V供电。开启时, 48V指示灯长亮蓝光, 关闭时, 48V指示灯熄灭;

④ 麦克风音量指示灯:分别显示两路麦克风音量大小,直播时,指示灯跟随麦克风音量大小动态变化;

⑤ 伴奏音量指示灯:显示伴奏音量大小,直播时,指示灯跟随伴奏音量大小动态变化;

⑥ 主播特效:8个主播特效,其中有6个固定音效,分别是:掌声、哄笑、乌鸦、欢呼、鄙视、亲嘴;有2个自定义特效,分别是:A、B,特效可根据个人喜好进行自由更换,更换方法详见说明书的“自定义主播特效”部分。当点按主播特效时,开始播放特效。播放特效过程中,如果再点按该特效按键,将立即停止播放;

⑦ 声音屏蔽按键:当不想让网络对方听到自己说话内容时,长按该按键,可传出“哔”声,同时麦克风会静音,直到释放该按键时“哔”声停止,麦克风恢复正常拾音状态;

⑧ 灯控按键:点按灯控按键,可切换多种灯光效果模式,有七色循环模式、七色常亮模式、七色呼吸模式等;

⑨ 蓝牙按键:循环点按蓝牙按键,开启或关闭蓝牙功能,蓝牙配对方法详见说明书的“蓝牙配对”部分;

⑩ 电音按键:循环长按电音按键,开启或关闭电音效果。开启电音时,指示灯长亮红灯,关闭时,指示灯熄灭。电音开启状态下,循环点按切换12种电音基调,并有相应的语音提示,分别是:C大调,降D大调,D大调,降E大调,E大调,F大调,降G大调,G大调,降A大调,A大调,降B大调,B大调;

⑪ 内放按键:循环点按内放按键,开启或关闭内放功能。内放开启时,指示灯长亮绿灯,电脑播放的音乐能够发送给电脑直播间。内放关闭时,指示灯熄灭,电脑播放的音乐不能发送给电脑直播间;

提示:在电脑直播平台的自由聊天模式下使用时,请关闭内放功能,否则直播间的人说话会听到双重音。其它模式下请开启内放功能,否则电脑播放的伴奏不会发送到电脑直播间。

⑫ 降噪按键:循环点按降噪按键,开启或关闭降噪功能。开启降噪时,指示灯长亮橙灯,可以自动屏蔽麦克风对环境噪声的拾取。关闭时,指示灯熄灭;

⑬ 闪避按键:循环点按闪避按键,开启或关闭闪避效果。开启闪避时,指示灯长亮白灯,说话背景音乐会自动压低音量。关闭时,指示灯熄灭;

⑭ 伴奏音量旋钮:顺时针旋转增加伴奏音量,反之减少伴奏音量;

说明:伴奏音量旋钮只控制通过蓝牙及Φ3.5MM伴奏接口的方式连接的设备所播放的音量大小,对于通过USB接口及Φ3.5MM手机接口的方式连接的设备所播放音量不起作用。当直播或播放设备(如电脑或手机)通过USB接口及Φ3.5MM手机接口的方式连接声卡时,需要在电脑或手机端调整播放音量大小。

⑮ 麦克风音量旋钮1/2:分别控制两路麦克风音量。顺时针旋转增加麦克风音量,反之减少麦克风音量;

⑯ 耳机音量旋钮1/2:分别控制两路耳机音量。顺时针旋转增加耳机音量,反之减少耳机音量;

⑰ 高/低音旋钮:调节麦克风高、低音。调到中间档为平衡状态,从中间开始顺时针旋转增加高音,从中间开始逆时针旋转增加低音;

⑱ 混响量旋钮:顺时针旋转增加麦克风混响量,反之减少麦克风混响量;

⑲ 电音速度旋钮:在电音效果开启的状态下,顺时针旋转增强电音强度,反之减少电音强度;电音效果关闭状态下,该旋钮不起作用。

⑳ 变声量旋钮:调到中间为正常状态,从中间顺时针旋转使变声效果变得尖锐,从中间逆时针旋转使变声效果变得低沉;

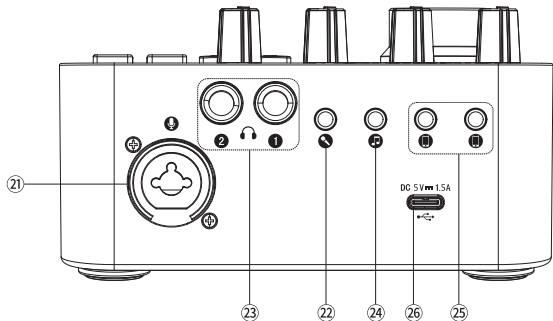

- ②1 话筒接口1:1个XLR及 $\Phi 6.35\text{mm}$ 合并式接口,当连接的麦克风需要48V幻象供电时,请使用平衡卡侬XLR接口;
- ②2 话筒接口2:可连接 $\Phi 3.5\text{mm}$ 接口的话筒(动圈话筒或免电源的电容话筒);
- ②3 耳机接口:连接耳机或有源音箱;
- ②4 伴奏接口:通过伴奏线与外部音源设备连接,方便直播时播放伴奏;
- ②5 手机接口1/2:通过音频线与直播或K歌的手机、平板连接,两个直播接口可分别连接两部手机或平板同步直播;
- ②6 Type-C接口:通过Type-C数据线可以为声卡充电。此外MX1 Pro还内置数字芯片,支持OTG功能,可以通过Type-C数据线与电脑或手机连接实现无损数字传输,系统自动识别声卡,即插即用,具体方法详见说明书的“使用说明”部分。

■ 使用说明

一、软件下载

1. 在手机或电脑APP市场下载各种直播APP或录音软件；
2. 也可以通过网页浏览下载，搜索APP软件名称，注意根据手机及电脑系统下载相应版本。

二、手机直播/K歌

1. 将耳机连接到声卡 $\Phi 6.35\text{mm}$ 耳机接口，如果耳机插头是 $\Phi 3.5\text{mm}$ 规格的，则通过声卡配送的 $\Phi 3.5$ 转 $\Phi 6.35$ 插头进行转接；

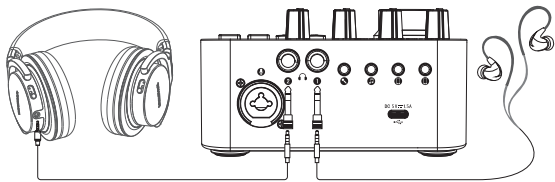

耳机连接示意图

2. 声卡与直播手机连接的方法有两种，一种是通过 $\Phi 3.5\text{mm}$ 接口的模拟信号连接方法，另一种是通过Type-C接口的数字信号连接方法。数字连接的录音品质及音乐音质更加清晰，保真度更高。

① 通过音频线将手机的 $\Phi 3.5\text{mm}$ 耳机接口与声卡的手机接口连接, 如果手机没有耳机接口的, 需配合OTG转接头使用 (OTG转接头需自行另购);

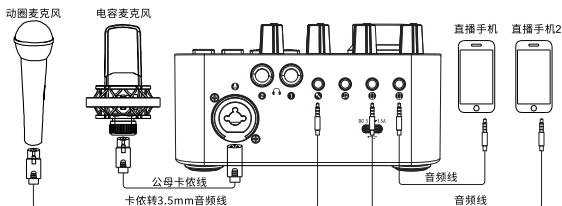

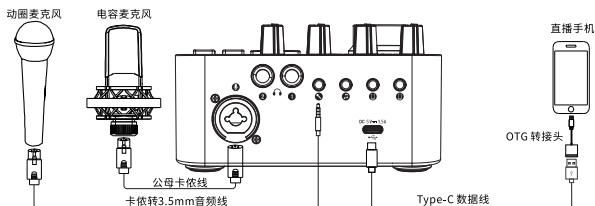

$\Phi 3.5\text{mm}$ 连接示意图

② 通过Type-C数据线将声卡Type-C接口与手机的数据接口连接, 苹果手机需要采用苹果相机套件, 安卓手机需要采用的USB转Type-C转接头; (此两样转接头需要自行另购)



OTG连接示意图

3. 将电容麦克风通过公母卡侖线连接到声卡标有“”符号的麦克风接口，然后将声卡的48V开关打开，动圈麦克风则无需开启48V开关。免电源的电容麦克风或动圈麦克风可以接到声卡标有“”符号的麦克风接口；

提示：如果声卡需要边充边用，建议连接充电宝给声卡充电。如连接电源适配器上充电使用，有可能会产生电流声。

4. 开启声卡，打开手机K歌或直播APP就可以开始手机K歌、直播之旅了。

提示：强烈建议购买苹果手机原装相机套件或原装Type-C转接头，否则有可能会出现问题。

三、连接伴奏手机

针对部分手机直播APP无伴奏功能或者在直播手机上播放伴奏不方便的问题，声卡增加了伴奏接口，实现一部手机用于直播，另一部手机用于播放伴奏的需要。

1. 按手机K歌的方法将相关的设备连接好；
2. 通过音频线将第二部手机与声卡的伴奏接口连接；
3. 开启声卡，打开直播APP，用伴奏手机播放伴奏，即可开启直播之旅。

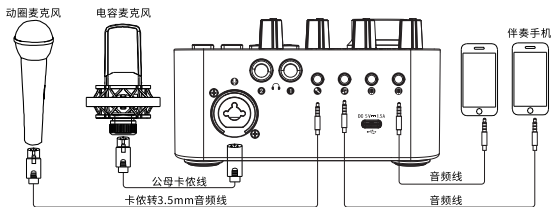

伴奏手机连接示意图

四、电脑手机同步直播

1. 按手机K歌的方法将相关的设备连接好；

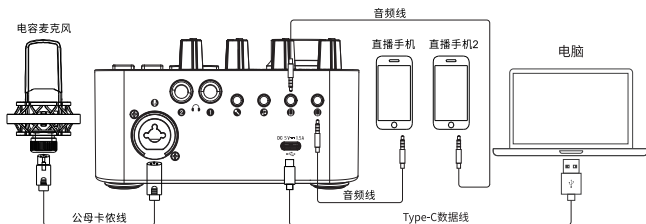

电脑连接示意图

2. 通过Type-C数据线将声卡与电脑的USB接口连接，电脑将自动识别声卡并完成驱动安装；

3. 将系统喇叭“播放”及“录制”设备“TAKSTAR MX1 Pro Audio”设置为默认设备；

4. 开启声卡，同时打开电脑及手机直播软件，即可实现电脑、手机同步直播。



五、音响K歌

连接音响K歌与手机K歌的方法雷同，只需要把耳机换成连接有源音箱即可。

提示：为了避免连接有源音箱K歌时容易产生啸叫的问题，连接音响K歌建议使用动圈麦克风，不要使用电容麦克风。将动圈麦克风的拾音部分背对有源音箱，同时保持适当距离，减小麦克风音量或有源音箱输出音量。

六、自定义主播特效

自定义主播特效软件可通过登录得胜官网的服务支持页面进行下载；

A. 自定义主播特效软件可以根据自己的需要把特效软件里的音效加载储存到声卡上，例如想把特效软件里的“出场音效”加载到声卡的按键A上，操作方法如下：

1. 通过配送的Type-C数据线连接电脑，打开MX1 Pro声卡自定义主播特效软件；
2. 鼠标右键点击“出场音效”，选择“载入设备”选项，然后有按键A、按键B两个选项，分别对应声卡上的A、B两个按键；我们是需要把特效加载到按键A上，所以我们选择“按键A”，出现文字提示“数据传据中，请稍后”，并有进度条提示加载进度，等待提示文字消失后音效加载完成。



B. 热键(即快捷键)功能,可以通过点按电脑键盘上的按键实现播放音效,而无需用鼠标点击音效,使用更方便。例如想把特效软件里的“出场音效”设置快捷键,操作方法如下:

1. 鼠标右键点击“出场音效”,选择“设置热键”选项(如该音效设置过快捷键,则为选择“修改热键“,在”请输入热键“对话框里按下相应的按键,如选F3,然后确定即可;
2. 鼠标右键点击“出场音效”,选择“删除热键“选项,则把该音效的快捷键功能去除。



七、蓝牙配对

首次使用蓝牙时,需要进行蓝牙配对连接,方法如下:

1. 在声卡开启的状态下,点按蓝牙按键,蓝牙指示灯蓝灯闪烁,表示正在蓝牙搜索配对状态;
2. 进入手机的“设置”菜单,找到蓝牙功能选项,开启手机的蓝牙功能,待搜索到“TAKSTAR MX1 Pro”,点击“TAKSTAR MX1 Pro”进行连接,当蓝牙指示灯恢复常亮,表示蓝牙连接成功;
3. 下次打开蓝牙功能时,如果已有连接过蓝牙,则自动回连;
4. 蓝牙连接成功的情况下,点按蓝牙按键断开蓝牙。

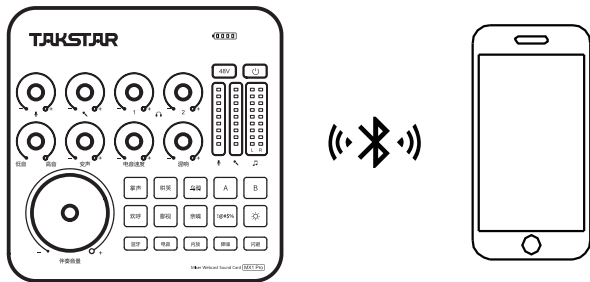

八、OTG兼容模式

MX1 Pro声卡可直接通过USB与iPad、iPhone连接实现高清无损录音、直播、音乐鉴赏等操作。

如果iOS系统版本过低,可能会出现不兼容的情况,具体要看iOS系统版本而定。我们强烈建议购买苹果原装相机套件。如果iPad、iPhone后面板装有保护壳,相机套件的插头可能发生插不紧或接触不良的情况,如果出现这种问题,请取下保护壳。

在较新版本的iOS中,连接后会显示设备名称。如果出现声卡与所接iPad、iPhone设备出现不兼容时,此时iPad、iPhone会检测到一个不兼容的USB设备,并显示提示信息“不可使用的设备——连接的USB设备不被支持”。或者由于iOS版本不同,可能存在部分APP无法使用或录音出现只录到单边声道的问题。

提示:MX1 Pro声卡还可以通过USB兼容部分安卓手机,由于市面上安卓手机品牌及系统版本过多,具体有什么机型可以兼容,要视实际应用情况而定,您可以自行测试,我们不便做出推荐。

九、充电说明

1. 可连接移动电源、电脑USB或电源适配器进行充电;
2. 长按声卡电源开关,电量指示灯不亮,说明声卡没电;电量指示灯剩下一格电量时,说明声卡电量不足,需及时充电;
3. 充电时,电量指示灯逐格流水点亮,表示正在充电中;充满电后,电量指示灯满格显示;使用5V直流电源充电,在充电电流1A的情况下,约5小时即可充满电;当电池电量充满时,请停止对电池充电,避免电池过充。

提示:初次使用时,建议先充满电;如长时间不用,要每半年给声卡充一次电,避免电池过放,对电池性能产生影响。

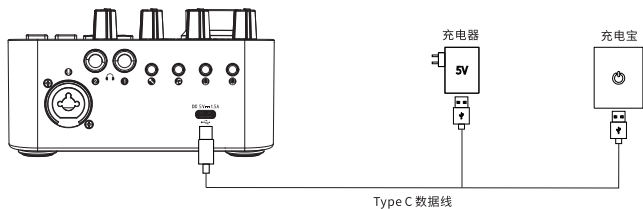

■ 故障处理

一、声卡开启后电量指示灯不亮

请检查声卡是否有足够的电量，请充电后再试。

二、播放音乐无声音

1. 检查声卡与手机或电脑连接的线材是否连接到位，请重新插拔后再试；
2. 检查耳机或耳麦是否连接到位，请重新插拔后再试；
3. 检查手机是否已正常收音，可以先退出再重新打开播放软件，看是否恢复正常。

三、话筒或耳麦没声音

1. 检查话筒或耳麦是否连接到位，请重新插拔后再试；
2. 检查声卡话筒音量或耳机音量是否调得过小，调节话筒音量及耳机音量看是否恢复正常。

四、录制的声音无效果

1. 检查声卡与手机或电脑连接的线材是否连接到位，请重新插拔后再试；
2. 检查用于录音的手机是否误接到了声卡的伴奏接口，伴奏接口是无法录制效果的。请重新将线材接到声卡的手机接口，然后把接手机一端的插头重新插拔一下再试。

五、无法录制话筒声音或录制声音过小

1. 检查声卡与手机或电脑连接的线材是否连接到位，请重新插拔后再试；
2. 检查录音软件的麦克风音量是否调得过小，调节之后看是否能恢复正常。

六、耳机监听有啸叫声

1. 话筒或耳麦是否连接到位，请重新插拔后再试；
2. 使用有耳返功能的手机时，请将APP耳返功能关闭。

七、电脑上直播听到双重音

在电脑直播平台的自由聊天模式下，内放功能会将对方传输过来的声音再传播到直播间里，从而导致直播间的人听到双重音。在自由聊天模式下，请关闭内放功能，其它麦序模式下开内放功能则无影响。

八、手机直播时听到双重音

1. 有部分手机直播APP没有耳返关闭功能, 这会造成直播时麦克风返听有双重音。当直播APP没有耳返关闭功能时, 请将手机的音量调到最小;
2. 当使用声卡的OTG功能连接手机进行连麦直播的情况下, 请关闭声卡内放功能。

■ 安全警示

为避免电击、高温、着火、辐射、爆炸、机械危险以及使用不当等可能造成的人身伤害或财产损失, 使用本产品前, 请仔细阅读并遵守以下事项:

1. 使用产品时适当调整音量大小, 不要在大音量下长时间使用, 以免造成听力损伤;
2. 使用中若发现有异常(如冒烟、异味等), 请立即关闭电源开关并拔掉电源插头, 然后将产品送经销商检修;
3. 本产品及配件都应放置在室内干燥通风处, 请勿长期存放在潮湿、灰尘多的环境, 使用中避免靠近火源、雨淋、进水、过度碰撞、抛掷、振动本机及覆盖通风孔, 以免损坏其功能;
4. 本产品不得遭受水滴或水溅, 产品上不得放置诸如花瓶类的装有液体的物品;
5. 清洁设备时, 使用柔软的干布, 请勿使用涂料稀释剂、溶剂、清洁液或浸了化学物质的抹布;
6. 使用该产品时需遵守相关安全规定, 法律法规明确禁止使用场合请勿使用本机, 以免导致意外事故;
7. 请不要自行拆机改装或维修, 以防止出现人身伤害, 如有问题或服务需求请联系当地经销商跟进处理。未经同意对本设备进行自行拆机改装或维修, 可能会失去由得胜公司提供的保修服务;
8. 请使用制造商指定的附件。

■ 关于图标含义解释



此符号表示,根据WEEE指令(2012/19/EU)和国家法律,由于这种类型的废弃物会有潜在的有害物质,可能对环境 and 人类健康产生负面影响,所以本产品不应与您的家庭垃圾一起处置,应将本产品交由授权的电气和电子设备(WEEE)回收站回收。同时,您在正确处理本产品的同时将有助于自然资源的有效利用。如需了解更多有关您以在何处放置废物回收设备的信息,请联系您当地的城市办事处、废物管理局或家庭废物处理服务部门。

■ 关于本说明书

本说明书中内容符合截止印刷之日的技术规格。由于得胜公司会不断改进产品,本说明书可能不符合您的特定产品的技术规格。要获取最新版说明书,请访问得胜官网,然后下载说明书文件。技术规格、设备或另售的附件在各个地区可能有所不同,如有问题请与当地得胜经销商确认。如需更多支持和深层产品信息,请浏览得胜官方网站:<https://www.takstar.com/>

■ 环保说明

产品中有毒有害物质或元素的名称及含量标识表

部件名称	有毒有害物质或元素					
	铅 (Pb)	汞 (Hg)	镉 (Cd)	六价铬 (Cr(VI))	多溴联苯 (PBB)	多溴二苯醚 (PBDE)
塑料部件	○	○	○	○	○	○
金属部件	×	○	○	○	○	○
电路板组件	×	○	○	○	○	○
线缆	×	○	○	○	○	○

本表格依据SJ/T 11364的规定编制。

○: 表示该有害物质在该部件所有均质材料中的含量均在 GB/T 26572规定的限量要求以下。

×: 表示该有害物质至少在该部件的某一均质材料中的含量超出 GB/T 26572规定的限量要求。

此标志为产品的环保使用期限标志，
且此环保使用期限只适用于产品正常工作的温度和湿度等条件。



Preface.....	22
Features.....	22
Product contents.....	23
Applications.....	23
Compatibility.....	23
Specifications.....	24
Sound card specification.....	24
Battery specification.....	24
Connector specification.....	24
Function instructions.....	25
Operation instructions.....	29
I . Software download.....	29
II . Webcast/Karaoke.....	29
III. Connecting a cell phone (for accompaniment).....	31
IV. Simultaneous webcast via a PC and a cell phone.....	32
V . Karaoke via speakers.....	33
VI. Customizing host effects.....	34
VII. Bluetooth pairing.....	35
VIII. OTG compatibility mode.....	36
IX. Charging instructions.....	37
Troubleshooting.....	38
Safety instructions.....	39
Meanings of icons.....	41
About the manual.....	41

■ Preface

Dear Customer,

Thank you for purchasing TAKSTAR MX1 Pro Mixer Webcast Sound Card. Please read the user manual carefully before use and keep it for reference in future.

If you have any questions or suggestions, please contact our local dealer.

■ Features

- Tailored for entertainment webcast, influencer marketing webcast, Karaoke and recording, and suitable for smartphones, tablets and PC
- Built-in DSP digital chip, independent adjustment of REVERB, VOICE and RETUNE SPEED, easy operation
- Bluetooth playing function without the trouble of cable connection to play music more freely
- Adjustment knobs of treble and bass to meet the voice characteristics of different people
- OTG function for the MX1 Pro sound card to connect with a mobile phone via USB to realize high-definition, lossless recording and webcast
- Colorful and cool lighting control for you to switch the lighting effect through the lighting control button
- 8 sound effects for the host to use, 2 of which can be changed freely, thus making webcast more interesting
- Smart noise reduction to shield the microphone from picking up environmental noise, thus making singing noise-free
- One-button ducking function to automatically lower the background music when talking, suitable for webcast
- Supporting simultaneous webcast using two mobile phones and one computer, multi-platform webcast to attract fans
- Built-in high-capacity lithium battery for ultra-long life battery, and convenient to carry and use outdoors

■ Product contents

Sound card.....	1 pc
Audio cable (Φ3mm*1.2m).....	2 pcs
Type-C data cable (Φ4mm*1.2m).....	1 pc
6.3mm to 3.5mm plug.....	2 pcs
User manual.....	1 pc

■ Applications

Cell phone/Tablet/PC: Karaoke, webcast, recording

Suitable for a variety of entertainment webcast APPs and influencer marketing platforms

■ Compatibility

Compatible with iOS, Android and windows

■ Specifications

Sound Card Specification

Data Transmission: USB2.0

Sample Rate: 48KHz/16bit

Frequency Response: 20Hz-20KHz ($\pm 3\text{dB}$)

THD: THD $<0.5\%$ 1KHz

Headphone Output Power: 167.7mW/32 Ω

Headphone S/N Ratio: 90dB (A-Weighted)

Main Chip: DSP

Reverb Mode: Reverb

Autotune: 12 kinds of autotunes

EQ Processing: EQ

Net Weight: approx. 490g

Connector Specification

Audio Connector: Cell phone connector *2 ($\Phi 3.5\text{mm}$)

Accompaniment connector ($\Phi 3.5\text{mm}$)

Microphone connector 1 (XLR+ $\Phi 6.35\text{mm}$)

Microphone connector 2 ($\Phi 3.5\text{mm}$)

Headphone connector *2 ($\Phi 6.35\text{mm}$)

Data Connector: Type-C connector

Battery Specification

Battery Type: Li-ion battery

Charging: DC 5V $\pm 1.5\text{A}$

Battery Capacity: 4400mAh

Charging Time: approx. 5h

Operation Time: approx. 8h(when 48V
is turned off)

approx. 6h(when 48V is turned on)

Note: The data is tested by Takstar Laboratory, and Takstar has the final interpretation right!

Function instructions

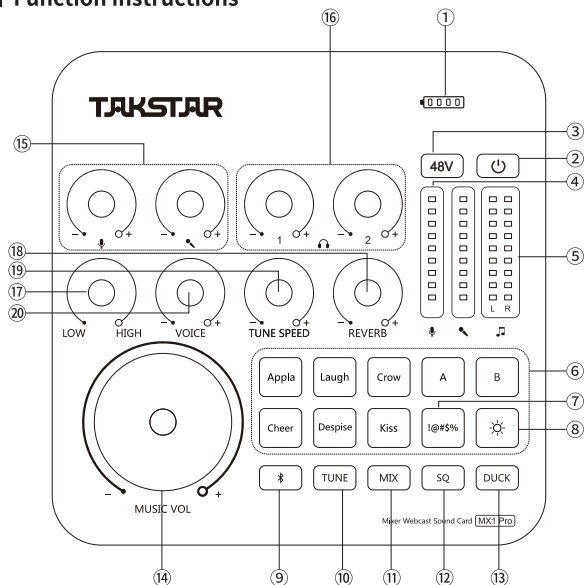

- 1 Battery LED:** The battery icon has four bars with each bar representing 25% power. When there is only one bar left, the battery LED lights up red, indicating that the sound card has insufficient power and needs to be charged in time. When the sound card is charging, the four bars light up one by one; when fully charged, all four bars light up.
- 2 Power button:** Long press it for two seconds to turn on or off the sound card. The power LED lights up blue when the sound card is turned on and lights off when the sound card is turned off.
- 3 48V switch:** Press it to turn on or off the 48V power supply. The 48V LED lights up blue when the 48V switch is turned on and lights off when the 48V switch is turned off.

- ④ Microphone volume LEDs: Display the microphone volume. During webcast, microphone volume LEDs light up dynamically based on the microphone volume.
- ⑤ Accompaniment volume LEDs: Display the accompaniment volume. During webcast, accompaniment volume LEDs light up dynamically based on the accompaniment volume.
- ⑥ Host special effects: There are totally 8 host special effects, six of which are fixed, including applause, laugh, crow, cheer, despise, and kiss. The other two effects of A and B are user-defined and subject to change based on personal preference. The methods of changing effects are written in details at the part of "Customizing host effects" on the user manual. The special effect starts to play when the corresponding button is pressed, and stops playing when the button is pressed again.
- ⑦ " !@#%\$ " Voice shielding button: When you do not want the other side to hear what you are saying, you can long press the button, and the microphone is muted when you hear a "beep" sound. The "beep" sound stops when you release the button, and the microphone picks up sounds again.
- ⑧ " * " Lighting control button: Press it to switch between multiple lighting modes: 7-Colors Cycle Mode, 7-Colors Constant Light Mode, 7-Colors Breathing Mode, etc.
- ⑨ Bluetooth button: Press it to turn on or off the Bluetooth function. For the methods of Bluetooth pairing, please refer to the "Bluetooth pairing" on the user manual.
- ⑩ TUNE button: Long press it to turn on or off the autotune function. When the autotune function is on, the TUNE LED lights up red; when the autotune function is off, the TUNE LED lights off. At the state of autotune, press the button to switch between the 12 autotunes with voice prompts. They are C, Db, D, Eb, E, F, F#, G, Ab, A, Bb, B.
- ⑪ MIX button: Press it to turn on or off the mixing function. When the mixing function is on, the MIX LED lights up, and the music played on the computer can be sent to the webcast room; when the mixing function is off, the MIX LED lights off, and the music played on the computer cannot be sent to the webcast room.

Note: When using the sound card in the free chatting mode of the webcast platform, please turn off the mixing function, otherwise there will be two sounds when people in the webcast room speak. Please turn on the mixing function in other modes, otherwise the accompaniment music played on the computer will not be sent to the webcast room.

⑫ SQ button: Press it to turn on or off the noise reduction function. When the noise reduction function is on, the SQ LED lights up orange, and it helps to prevent the microphone from picking up ambient noise; when the noise reduction function is off, the SQ LED lights off.

⑬ DUCK button: Press it to turn on or off the ducking function. When the ducking function is on, the DUCK LED lights up white, and the background music will be lowered automatically when people speak; when the ducking function is off, the DUCK LED lights off.

⑭ MUSIC VOL knob: Turn it clockwise to increase the accompaniment volume and turn it counterclockwise to decrease the accompaniment volume.

Note: The MUSIC VOL knob controls only the playback volume of the device connected via Bluetooth and a $\Phi 3.5\text{mm}$ accompaniment connector but not that of the device connected via a USB connector and a $\Phi 3.5\text{mm}$ cell phone connector. When a live streaming device or a playback device (a computer or a cell phone) is connected to the sound card via a USB connector and a $\Phi 3.5\text{mm}$ cell phone connector, the playback volume needs to be adjusted on the computer or the cell phone.

⑮ MIC VOL knobs 1/2: Control two ways of microphone volume respectively. Turn it clockwise to increase the microphone volume and turn it counterclockwise to decrease the microphone volume.

⑯ Headphone VOL knobs 1/2: Control two ways of headphone volume respectively. Turn it clockwise to increase the headphone volume and turn it counterclockwise to decrease the headphone volume.

⑰ HIGH/LOW knob: Adjust the treble and bass of microphones. It starts in the middle position. Turn it clockwise starting in the middle position to increase the treble and

turn it counterclockwise starting in the middle position to increase the bass.

⑱ REVERB knob: Turn it clockwise to increase the microphone reverb and turn it counterclockwise to decrease the microphone reverb.

⑲ RETUNE SPEED knob: When the auto-tuning function is on, turn the knob clockwise to strengthen the auto-tuning effect and turn it counterclockwise to weaken the auto-tuning effect; when the auto-tuning function is off, the knob doesn't work.

⑳ VOICE knob: It starts in the middle position. Turn it clockwise starting in the middle position to sharpen the voice and turn it counterclockwise starting in the middle position to deepen the voice.

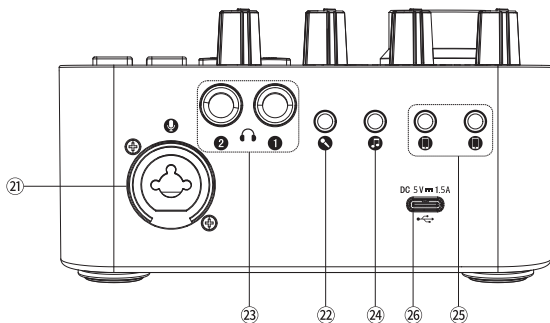

⑳ Microphone connector 1: One combined connector with XLR and $\Phi 6.35\text{mm}$. When the connected microphone needs 48V phantom power supply, please use the balanced XLR connector.

㉑ Microphone connector 2: Connect to a microphone with a $\Phi 3.5\text{mm}$ connector (a dynamic microphone or a power-free condenser microphone).

㉒ Headphone connector: Connect to headphones or active speakers.

㉓ Accompaniment connector: Connect to external audio equipment via an accompaniment cable, making it convenient to play accompaniment during the webcast.

- ②⑤ Cell phone connectors 1/2: Connect to the cell phone or tablet for webcast or Karaoke via an audio cable. Two cell phone connectors are available for the simultaneous webcast via two cell phones or two tablets.
- ②⑥ Type-C connector: Charge the sound card via a Type-C data cable. In addition, MX1 Pro also has a built-in digital chip that supports OTG function. It can connect to a computer or a cell phone via a Type-C data cable to achieve lossless digital transmission. The system automatically recognizes the sound card. Plug and play. For details, please refer to the "Operation instructions" on the user manual.

■ Operation instructions

I . Software download

1. Download various webcast apps or recording software in the APP market on your cell phone or computer;
2. Download the corresponding version according to the system of your cell phone or computer through the webpage.

II . Webcast/Karaoke

1. Plug the headphone into the $\Phi 6.35\text{mm}$ headphone connector on the sound card. If the headphone plug is of $\Phi 3.5\text{mm}$, then use the $\Phi 3.5\text{mm}$ to $\Phi 6.35\text{mm}$ plug delivered along with the sound card as the adapter.

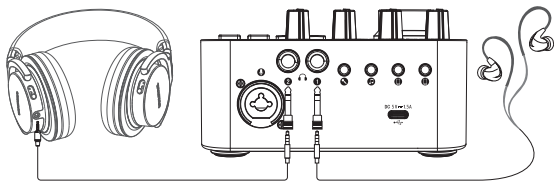

Headphone connection diagram

2. There are two ways to connect the sound card to the cell phone. One is the analog signal connection through the $\Phi 3.5\text{mm}$ connector, and the other is the digital signal connection through the Type-C connector. The recording quality and sound quality of the digital connection are of higher definition and fidelity.

① Connect the $\Phi 3.5\text{mm}$ headphone connector on the cell phone to the cell phone connector on the sound card via an audio cable. If the phone has no headphone connector, use an OTG adapter for the connection (buy an OTG adapter additionally).

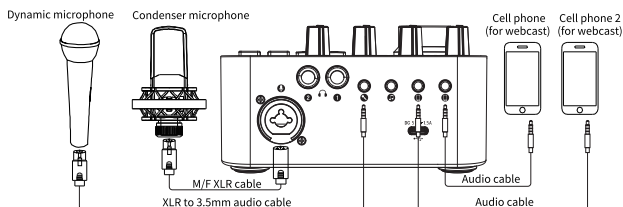

$\Phi 3.5\text{mm}$ connection diagram

② Connect the Type-C connector on the sound card to the data connector on the cell phone via a Type-C data cable. iPhones require relative accessories, and Android cell phones require a USB to Type-C adapter (buy both adapters additionally).

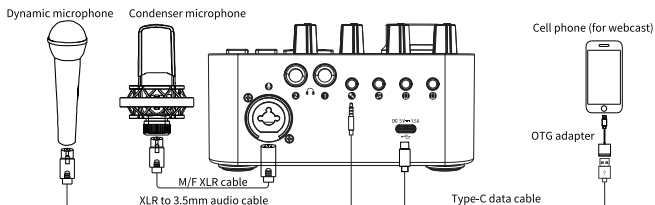

OTG connection diagram

3. Connect the condenser microphone to the microphone connector marked with the symbol "🎤" on the sound card through the M/F XLR cable and then turn on the 48V switch of the sound card. There is no need to turn on the 48V switch of the dynamic microphone. The power-free condenser microphone or dynamic microphone needs to connect to the microphone connector marked with the symbol "🎧" on the sound card.
Note: If the sound card is in use while charging, it is recommended to connect a power bank to charge the sound card. If it is connected to a power adapter for charging, the sound of electric currents may occur.
4. Turn on the sound card, and open the Karaoke or webcast APP on the cell phone for use.

Note: It is recommended to use iPhone accessories or an original Type-C adapter, otherwise there will be a compatibility problem.

III. Connecting a cell phone (for accompaniment)

To address the problem that some webcast APPs don't have the accompaniment function or it is inconvenient to play accompaniment on the cell phone (for webcast), an accompaniment connector is added on the sound card to meet the needs of using one phone for webcast and the other for accompaniment.

1. Make sure relevant devices are connected for the Karaoke on a cell phone;
2. Connect the second cell phone to the accompaniment connector on the sound card through an audio cable;

3. Turn on the sound card, open the webcast APP, and play accompaniment through a cell phone (for accompaniment) for the webcast.

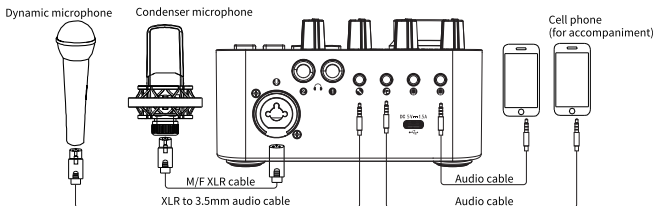

Cell phone (for accompaniment) connection diagram

IV. Simultaneous webcast via a PC and a cell phone

1. Make sure relevant devices are connected for mobile Karaoke;

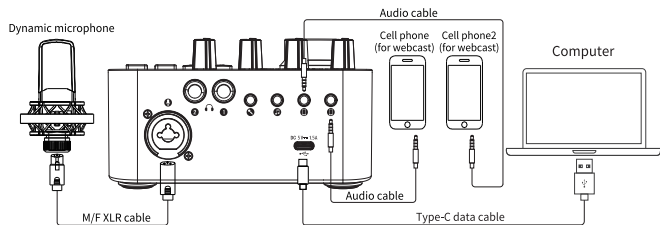

Computer connection diagram

2. Connect the sound card to the USB interface on the computer through a Type-C data cable, and the computer will identify the sound card and install the driver automatically;
3. Set "TAKSTAR MX1 Pro Audio" as the default device;
4. Turn on the sound card, and open the webcast software on the computer and the cell phone at the same time to realize the simultaneous webcast on both devices.

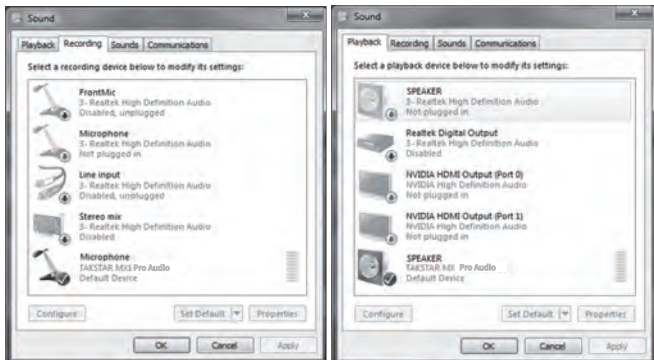

V. Karaoke via speakers

The method of connecting speakers for Karaoke is the same as that of connecting cell phones for Karaoke. You just need to replace headphones with active speakers.

Note: To avoid the feedback caused when connecting active speakers for Karaoke, it is recommended to use dynamic microphones instead of condenser microphones. In addition, make sure the microphone cartridge face away the active speakers and keep a proper distance to decrease the microphone volume or the output volume of the active speakers.

VI. Customizing host effects

The software for customizing host effects can be downloaded from the service support page of Takstar's official website.

A. You can add and store the sound effects from the software on the sound card based on your needs. For example, if you would like to add the "Entry sound effect" from the software to the button A on the sound card, you can do the following.

1. Connect to a computer via a Type-C data cable, and open the software for customizing host effects on the MX1 Pro sound card.
2. Right-click the "Entry sound effect", select "Loading a device", and then there are two options of button A and button B, corresponding to the two buttons A and B on the sound card. We need to add the special effect to the button A, so we select "Button A". There is a text prompt "Data transmitting, please wait" and a progress bar reminding the loading progress. The loading of the sound effect is completed after the text prompt disappears.



B. Hotkey (shortcut key) function. You can click the button on the computer keyboard to play the sound effect, instead of clicking the sound effect with the mouse, which is more convenient. For example, if you would like to set a shortcut key for the "Entry sound effect", you can do the following.

1. Right-click the "Entry sound effect" and select the "Set a hotkey" option; if the sound effect has been set with a shortcut key, select "Modify a hotkey", press the corresponding key in the dialog box of "Please enter a hotkey", and then press "Confirm".
2. Right-click the "Entry sound effect" and select the "Delete a hotkey" option to remove the shortcut key of the sound effect.

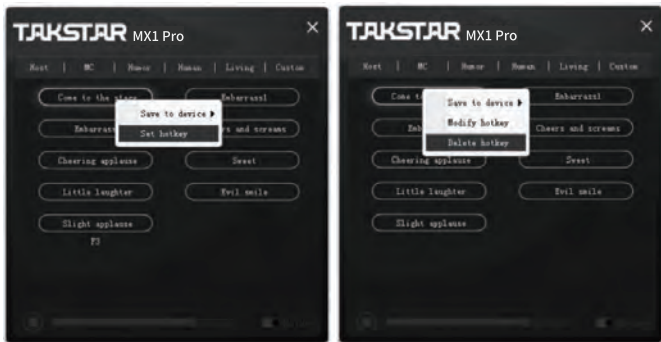

VII. Bluetooth pairing

If it is your first time to use Bluetooth, you need to pair the Bluetooth according to the below steps.

1. When the sound card is turned on, press the Bluetooth button, and then the Bluetooth indicator flashes blue, indicating that the Bluetooth is searching for pairing status;
2. Enter the "Settings" menu of the cell phone, find the Bluetooth function option, and turn it on. After searching for "TAKSTAR MX1 Pro", click "TAKSTAR

MX1 Pro" to connect. When the Bluetooth indicator returns to steady blue, it means the Bluetooth connection is successful.

3. Next time you turn on the Bluetooth function, if the sound card has been connected to Bluetooth once, it will automatically connect back.

4. When the Bluetooth connection is successful, press the Bluetooth button to disconnect it.

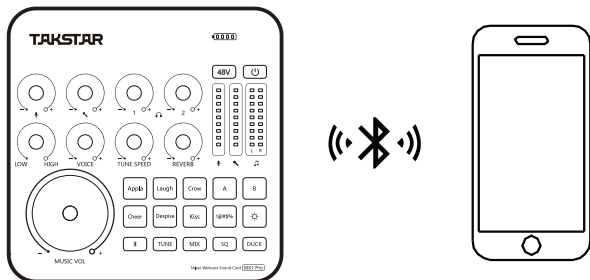

VIII. OTG compatibility mode

MX1 Pro sound card can be directly connected to iPad/iPhone via USB to realize high-definition lossless recording, webcasting, music appreciation, and other operations.

If the iOS system version is too low, incompatibility may occur, depending on the iOS system version. We strongly recommend you to purchase an original Apple camera kit. If the iPad or iPhone is equipped with a protective case on the rear panel, the camera kit plug may be improperly inserted or poorly connected. If this problem occurs, please remove the protective case.

In newer versions of iOS, the device name will be displayed after connection. If the sound card is incompatible with the connected iPad or iPhone device, the iPad or iPhone will detect an incompatible USB device and display the prompt message "Unusable device. The connected USB device is not supported".

Or due to different iOS versions, there may be problems that some APPs cannot be used, or the recording is only recorded in a single channel.

Note: MX1 Pro sound card can also be compatible with some Android phones via USB. Due to the excessive number of Android phone brands and system versions on the market, what models are compatible with the sound card depends on the actual application. You can test it yourself.

IX. Charging instructions

1. The sound card connects to a power bank, PC USB, or power adapter for charging.
2. Long press the power switch of the sound card. If the battery indicator does not light up, it indicates that the sound card is out of power. When the battery indicator has one bar of power remaining, it indicates that the sound card is of low battery and needs to be charged in time.
3. When charging, the battery LEDs light up one by one, indicating that it is charging; when fully charged, all battery LEDs are on; when charging with a 5V DC power supply, the sound card can be fully charged in about 5 hours with a charging current of 1A; when the battery is fully charged, please stop charging the battery to avoid overcharging.

Note: When using it for the first time, it is recommended to fully charge it; if it is not used for a long time, charge the sound card once every six months to avoid over-discharge of the battery and avoid affecting the battery performance.

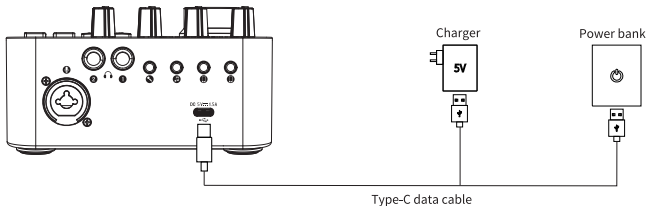

■ Troubleshooting

I . LED does not light up after the sound card is turned on.

Check if the sound card has sufficient power. If not, charge it and try again.

II . There is no sound when playing music.

1. Check if the sound card has been connected correctly to the cell phone or PC.

2. Check if the headphone has been connected correctly.

3. Check if the cell phone has played sound normally. If not, exit the software, play it again, and check the result.

III. The microphone sound cannot be monitored.

1. Check if the microphone or headphone has been connected successfully.

2. Check if the microphone volume or monitor volume has been decreased too much. If so, try to increase the volume and check the result.

IV. The recorded sound has no effect.

1. Check if the cell phone or PC has been connected to the sound card correctly. If not, reconnect it and try again.

2. Check if the recording cell phone has been connected to the accompaniment input connector which cannot be used to record effects. If so, reconnect the recording cell phone to the cell phone connector on the sound card and try again.

V . The microphone sound cannot be recorded or the recorded sound volume is too low.

1. Check if the cell phone or PC has been connected to the sound card correctly. If not, reconnect it and try again.

2. Check if the microphone volume of the recording software is decreased too much. If so, adjust the volume and check the result.

VI. The headphone has feedback.

1. Check if the microphone or headset has been connected correctly. If not, reconnect it and try again.

2. When the cell phone has the monitor function, please disable the monitor function of the APP.

VII. There are two sounds during the webcast on a PC.

In the free chatting mode, the mixing function will send the sound from the other side to you and then to the webcast room. This leads to two sounds in the webcast room. Please disable the mixing function in the free chatting mode.

VIII. There are two sounds during the webcast on a cell phone.

1. Some webcast APPs do not have the monitor function, which causes two sounds during the webcast. When webcast APPs do not have the monitor function, the cell phone volume should be minimized.

2. When using the OTG function of the sound card to connect to a cell phone for a webcast, please turn off the mixing function of the sound card.

■ Safety instructions

To avoid possible personal injury or property damage caused by electric shock, high temperature, fire, radiation, explosion, mechanical hazards, and improper use, please read and observe the following items before using the product.

1. Adjust the volume appropriately when using the product, and do not use it for a long time at a high volume to avoid hearing damage.
2. If there is any abnormality (such as smoke, odor, etc.) during use, please turn off the power switch and unplug the power plug immediately, and then send the product to the dealer for maintenance.
3. The product and accessories should be placed indoors in a dry and ventilated place. Do not store them in a humid and dusty environment for

a long time. Avoid getting close to fire, rain, water, excessive collision, throwing, vibrating the machine, and covering the ventilation holes during use, so as not to damage its function.

4. This product must not be exposed to water droplets or splashes, and no objects containing liquids such as vases should be placed on the product.

5. When cleaning the product, use a soft dry cloth and do not use paint thinners, solvents, cleaning fluids or rags soaked in chemicals.

6. When using the product, you must abide by relevant safety regulations.

Please do not use the product on occasions that are prohibited by laws and regulations to avoid accidents.

7. Please do not disassemble, refit or repair the product by yourself to prevent personal injury. If you have any questions or service needs, please contact the local dealer for the follow-up. Unauthorized disassembly, refit or repair of the product may result in the loss of the warranty service provided by Takstar.

8. Please use the accessories specified by the manufacturer.

■ Meanings of icons



This symbol indicates that according to the WEEE Directive (2012 / 19 / EU) and national laws, this product should not be disposed of together with your household waste, and should be returned to an authorized recycling station of electrical and electronic equipment (WEEE) for recycling, because this type of waste has potential harmful substances that may have a negative impact on the environment and human health. Meanwhile, when this product is disposed of properly, it is conducive to the effective use of natural resources. For more information on where you can place your waste recycling equipment, please contact your local City Office, Waste Management Bureau or Household Waste Treatment Service Department.

■ About the manual

The contents of this manual comply with the technical specifications as of the date of printing. Since Takstar continues to improve its products, this manual may not meet the technical specifications of your specific product. To get the latest version of the manual, please visit Takstar's official website and download the manual file. Technical specifications, equipment, or accessories (sold separately) may vary from region to region. If you have any questions, please check with the local dealer. For more information, please visit our website: <https://www.takstar.com/>.

产品服务保证书

姓名：_____ 电话：_____ 地址：_____

商品：_____ 型号：_____ 购买日期：_____ 年 ___ 月 ___ 日

维修记录栏 (由维修员填写)	维修员签名	日期

注意事项：

1. 本单为保修凭证，请用户妥善保管，如有遗失，恕不保修或退换。
2. 保修期限制：购买之日起十二个月内。
3. 除了不可抗力事件损坏外，由本公司负责，免费维修。
4. 如属保管不善或使用不当造成的损坏，维修点将酌情收费。
5. 擅自拆卸维修者，不予保修。
6. 以上保修条款仅限于中国市场适用（不含港澳台地区）。

◆ 广东得胜电子有限公司 ◆ 电话：400-6828-333 ◆ 地址：广东省惠州市博罗县龙溪街道富康一路2号



扫一扫，了解更多产品
Scan for more
product information

**广东省电声工程技术研究开发中心
广东得胜电子有限公司制造**

地址：广东省惠州市博罗县龙溪街道富康一路2号
服务热线：400 6828 333 传真：0752-6383950
邮箱：xs@takstar.com
网址：www.takstar.com

Guangdong Takstar Electronic Co., Ltd.
Address: No. 2 Fu Kang Yi Rd., Longxi Boluo
Huizhou, Guangdong 516121 China
Tel: 86 752 6383644 Fax: 86 752 6383952
Email: sales@takstar.com
Website: www.takstar.com

GB/T 8898-2011
GB/T 12060.3-2011
9TX1PROS1C